

CLOVER 3

Handheld Video Magnifier

User Guide

Rev F

Contents

Precaution	1
Quick Start	3
Overview	3
Compositions	5
Accessories	7
Charging the battery	8
Writing stand	12
Operation	13

Power Button	13
Beep Type	15
Magnification	16
Color Mode	17
Brightness	19
Lighting	20
Freeze	21
Memory	22
Auto power saving	22
Restore	23

Hardware Reset.....	23
Troubleshooting	25
The unit does not turn on.....	25
Black screen or White screen.....	25
The image does not change.....	26
Smudges or blemishes on the screen.....	27
Specifications	28

Precaution



Before using CLOVER 3 for the first time, you must charge its battery. Refer to **Charging the battery** section for more details.



Always operate the unit in a place where the temperature is between 10° and 35°C (50° and 95°F)



Keep the unit away from wet areas, rain, and other sources of liquids. Do not submerge the unit



Do not attempt to repair the unit. Any unauthorized attempt will void the product warranty. Contact your distributor to service.



Use the supplied power adapter.

Quick Start

Overview

Thank you for purchasing CLOVER 3.

CLOVER 3 is a pocket video magnifier with a 3.5 inch LCD display, providing sharp, clear images that are easily viewed in various magnification level and color mode.

The unit allows you to put the magnifier on or close to the object for continuous zoom or freeze the image

for further viewing. It also has an integrated fold-away writing stand. This unit is ideal for viewing labels, books, newspapers and more.



Compositions

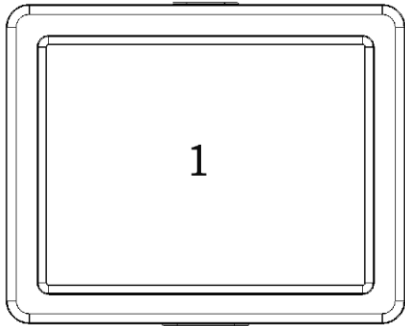

- 1. LCD screen
- 3. LED lights

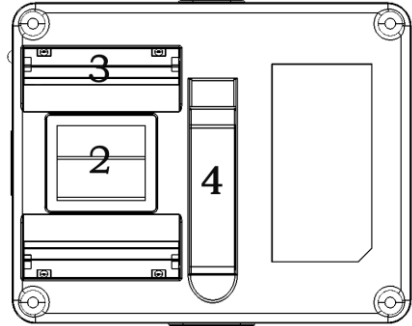

- 2. Camera
- 4. Stand

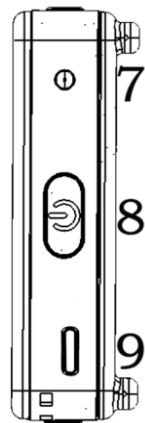
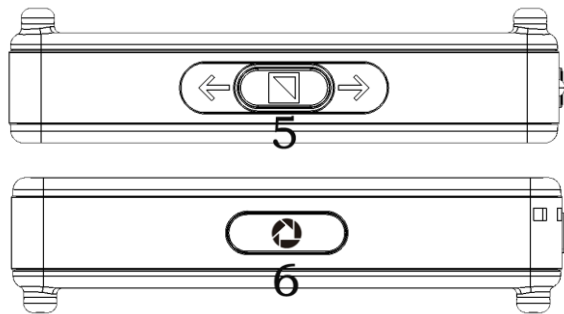

5. Zoom & Mode

7. Power LED

9. USB type-C Port

6. Freeze

8. Power

Accessories



User Manual



Power
Adapter



Cleaning Cloth



Carrying
Case

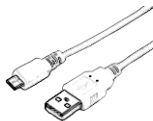

USB Cable



Wrist Cord

Charging the battery

1. Connect the supplied USB cable to the power adapter
2. Connect the supplied USB cable to the micro USB port on the unit
3. Plug the power adapter into an AC outlet and start charging

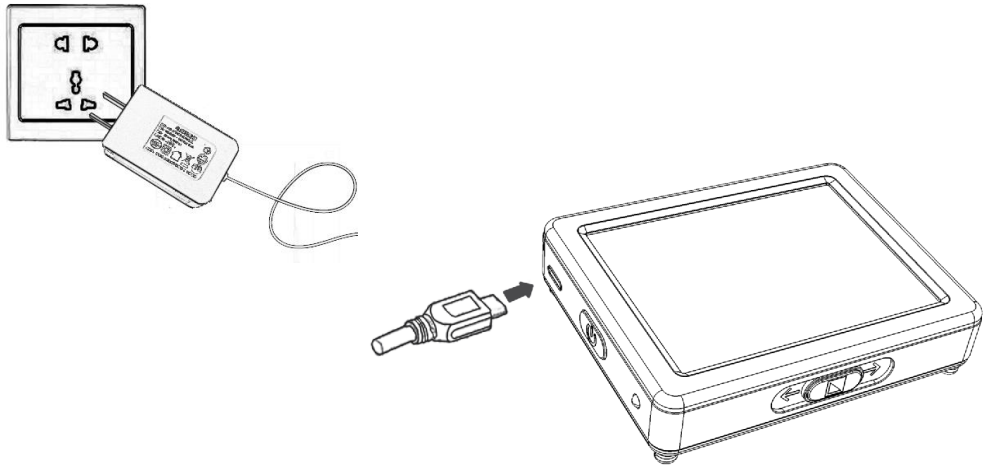

The status of Power LED indicator

- Charging when the unit is off, the power LED will be green, and then auto turn off when fully charged. A fully Charging will take about 3 hours, and will support the unit about 3 hours of continuous working
- When the unit is on, the power LED will be green when using the power adaptor

-
- When the unit is on and the power adaptor is not connected, the power LED will be green when the battery is high and will be red when the battery is low. When the red light starts to flash, you will need to charge the battery
 - You can also check the battery status by pressing the power button; refer to the following instructions for more details

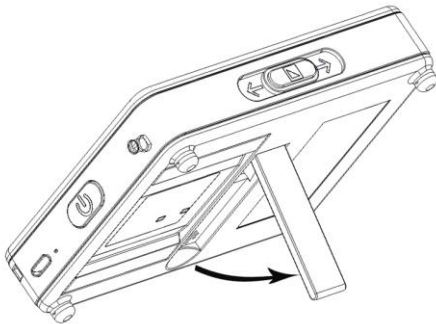

Writing stand

Release the writing stand as the following figure shows. And you can write under the camera within the comfortable viewing field.



Operation

Power Button

- Press and hold the Power button  for 3 seconds to turn on the unit when it is off
- Press and hold the Power button  for 3 seconds to turn off the unit when it is on

-
- ❑ Press the Power button  to check the current status of battery capacity, color mode, freeze mode , and beep
 - ❑ Press other button when holding the power button will make combo function, refer to the following instructions for more details







Beep Type

- Unit on/off beep
- Button beep
- Threshold beep
- Low battery beep

Beep Control:



- Press and hold the Freeze button  for 3 seconds to turn on/off the beep



Magnification

- ❑ Slide the Zoom & Mode button    rightward to increase magnification, and Holding for continuous increasing
- ❑ Slide the Zoom & Mode button    leftward to decrease magnification, and Holding for continuous decreasing
- Magnification range:
Flat on the table: 3.8x – 16x

Color Mode

A color mode is a pre-defined color combination. Full color mode is suitable for picture, map viewing, and enhanced contrast mode is combined with different foreground and background colors and can help to reading clearly.

- ❑ Press the Zoom & Mode button    to cycle in one direction through the color combination list





- ❑ Long press the Zoom & Mode button    for 2 seconds to quick switch between Full color mode and current enhanced contrast mode





The Color Combination List (10 modes)

- | | |
|--|---|
| <input checked="" type="checkbox"/> Full Color | <input checked="" type="checkbox"/> White on Black |
| <input checked="" type="checkbox"/> Black on White | <input checked="" type="checkbox"/> Yellow on Black |
| <input checked="" type="checkbox"/> White on Blue | <input checked="" type="checkbox"/> Blue on White |
| <input checked="" type="checkbox"/> Yellow on Blue | <input checked="" type="checkbox"/> Blue on Yellow |
| <input checked="" type="checkbox"/> Green on Black | <input checked="" type="checkbox"/> Red on Black |



Brightness

Adjust the display brightness for Full color mode and Enhanced contrast mode. Factory default value will be highlighted green.

- ❑ Combo: Holding Power button  and Slide the Zoom & Mode button    rightward to increase the brightness

- ❑ Combo: Holding Power button  and slide the Zoom & Mode button    leftward to decrease the brightness

Lighting

- ❑ Combo: Holding Power button  and click the Freeze button  to turn on/off the LED Lighting

Freeze

Freezing an image on the LCD screen can be useful for further reading, and also further zooming in or zooming out or changing the color mode for a better view. The brightness adjusting is not allowed when freezing.

- Press Freeze button  to lock the active image
- Press again Freeze button  to release



Memory

The unit will memorize automatically the most recent settings such as color mode, magnification, beep when power off normally and use them in the next power on.



Auto power saving



If no operation and no moving for over 3 minutes, the unit will turn off automatically.

Restore

- ❑ Holding the Freeze button  and Zoom & Mode button  at the same time for 5 seconds to reset to the default factory settings. Auto power off when resetting is done.

Hardware Reset

When the unit is hung or can't be shut down normally, press the Power  & Freeze button  & Zoom &

Mode button    at the same time to trigger the hardware reset.

Troubleshooting

The unit does not turn on

- Connect to the power adapter
- Charge the battery
- Reinstall the battery

Black screen or White screen

- If the unit is sitting on a flat pure surface, the screen may be black or white, Lift the unit off to ensure change happens

- Adjust the magnification
- Adjust the color mode
- When the unit is connected to TV, the screen is black
- Restart the unit
- Reinstall the battery

The image does not change

- If the unit enter the freeze mode, the image will not change

-
- Press power button to check the current status
 - Restart the unit
 - Reinstall the battery

Smudges or blemishes on the screen

- Adjust brightness
- Clean the LCD screen and camera

Please contact your local distributor if problem is not solved

Specifications

- **Display:** 3.5 inch LCD
- **Size:** $\leq 90 \times 72 \times 18$ mm
- **Weight:** < 150 grams (Battery included)
- **Color Mode:** 10 modes
- **Magnification:** 3.8x – 16x (Flat on the table)
- **Battery:** Integrated rechargeable Li battery; 3 hours continuous use; charges in approximately 3 hours
- **Power Adapter:** Micro USB port; input: 110-240V; output: 5V/1A